

THREE SPINDLE IN-LINE ADJUSTABLE DRILLING HEAD, MODEL MS3L-7

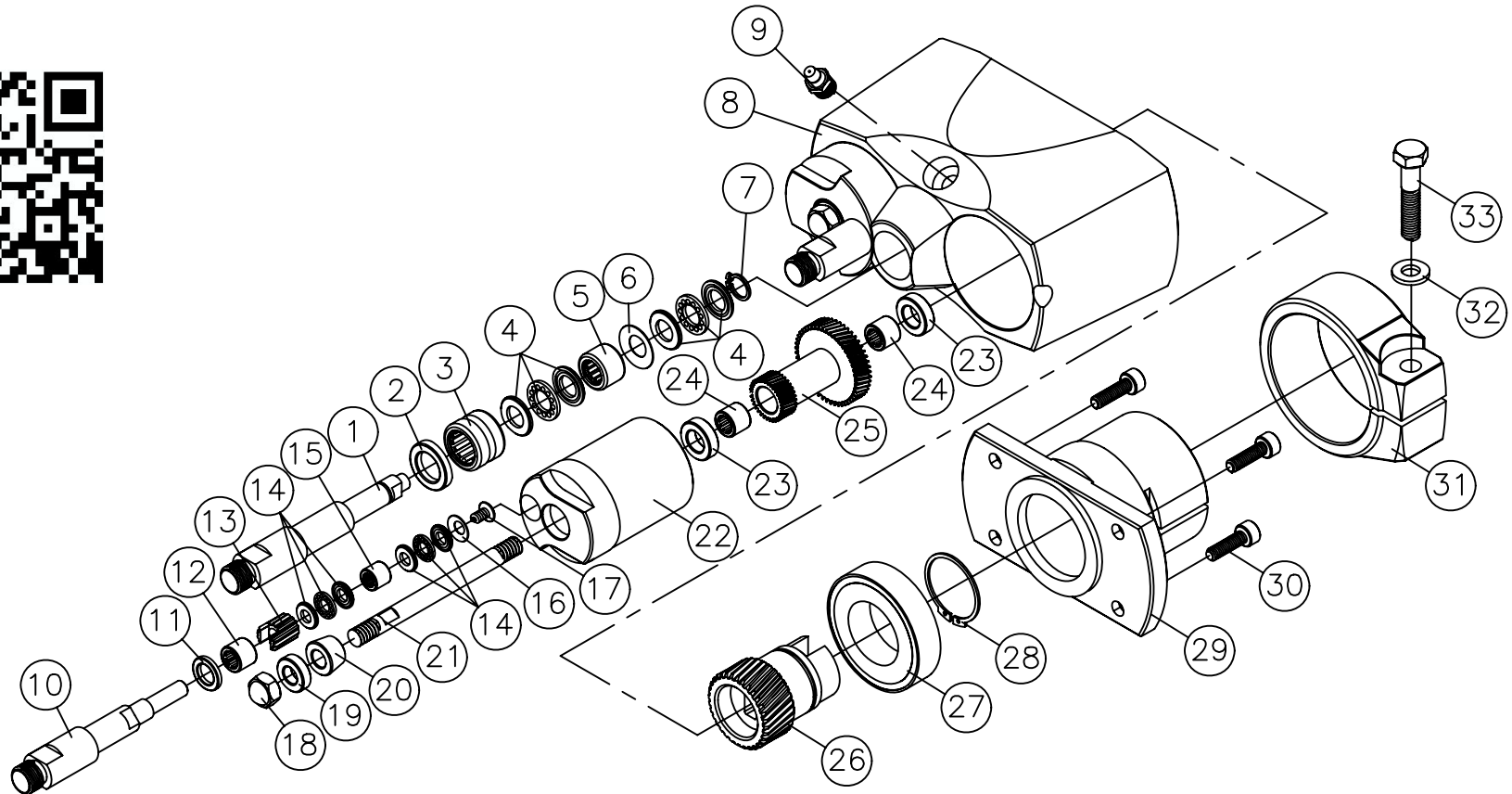

ITEM	QTY	DESCRIPTION	ITEM	QTY	DESCRIPTION	ITEM	QTY	DESCRIPTION
1	1	INTERMEDIATE SPINDLE	13	2	GEAR	25	2	GEAR SET
2	1	OIL SEAL	14	4	THRUST BEARING	26	1	DRIVE SPINDLE
3	1	NEEDLE BEARING	15	2	NEEDLE BEARING	27	1	BALL BEARING
4	2	THRUST BEARING	16	2	BELLEVILLE WASHER	28	1	SNAP RING
5	1	NEEDLE BEARING	17	2	SOCKET HEAD SCREW	29	1	ADAPTER
6	1	BELLEVILLE WASHER	18	2	NUT	30	4	SOCKET HEAD SCREW
7	1	SNAP RING	19	2	SPACER	31	1	ADAPTER CLAMP
8	1	HOUSING	20	2	CONICAL WASHER	32	1	ADAPTER CLAMP WASHER
9	1	GREASE FITTING	21	2	PRECISION STUD	33	1	ADAPTER CLAMP BOLT
10	2	SPINDLE	22	2	TURRET	34	3	COLLET
11	2	OIL SEAL	23	4	BRASS THICK WASHER	35	3	COLLET NUT
12	2	NEEDLE BEARING	24	4	NEEDLE BEARING			34 & 35 NOT SHOWN